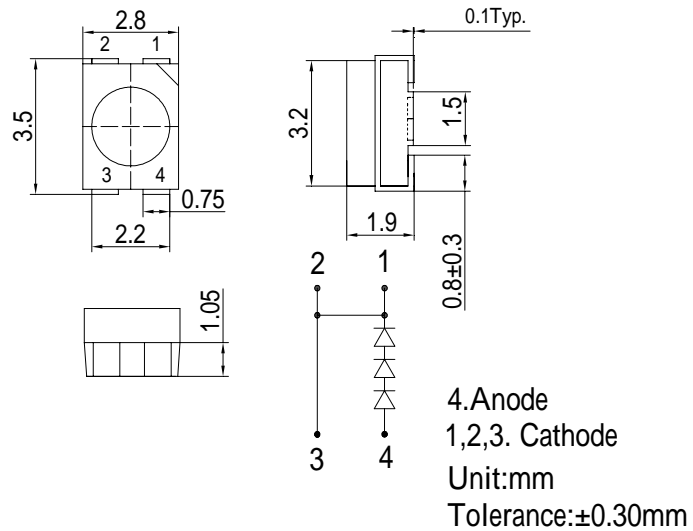

**■Features**

- High Luminous PLCC4 Power Top SMD LEDs
- 3.5x2.8x1.9mm Standard Directivity
- Superior Weather-resistance
- UV Resistant Epoxy
- Water Clear Type

**■Applications**

- Backlighting (switches, keys, etc.)
- Marker lights (e.g. steps, exit ways, etc.)
- Signal and Channel Letter
- Other Lighting

**■Outline Dimension**

**■Absolute Maximum Rating**

(Ta=25 )

Item	Symbol	Value	Unit
DC Forward Current	I <sub>F</sub>	30	mA
Pulse Forward Current*	I <sub>FP</sub>	100	mA
Reverse Voltage	V <sub>R</sub>	15	V
Power Dissipation	P <sub>D</sub>	195	mW
Operating Temperature	Topr	-30 ~ +85	
Storage Temperature	Tstg	-40~ +100	
Lead Soldering Temperature	Tsol	260 /5sec	-

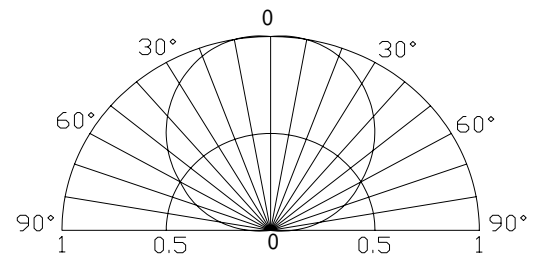
\*Pulse width Max.10ms Duty ratio max 1/10

**■Directivity**

**■Electrical -Optical Characteristics**

(Ta=25 )

Item	Symbol	Condition	Min.	Typ.	Max.	Unit
DC Forward Voltage	V <sub>F</sub>	I <sub>F</sub> =20mA	5.4	6.3	7.8	V
DC Reverse Current	I <sub>R</sub>	V <sub>R</sub> =15V	-	-	10	μA
Domi. Wavelength	λ <sub>D</sub>	I <sub>F</sub> =20mA	600	605	610	nm
Luminous Intensity*	I <sub>v</sub>	I <sub>F</sub> =20mA	2180	3000	-	mcd
50% Power Angle	2θ <sub>1/2</sub>	I <sub>F</sub> =20mA	-	120	-	deg

\*1 Tolerance of dominant wavelength is ±1nm

\*2 Tolerance of luminous intensity is ±15%